

**PowerMOS transistors  
Avalanche energy rated**

**PHP2N60E, PHB2N60E, PHD2N60E**

**FEATURES**

- Repetitive Avalanche Rated
- Fast switching
- Stable off-state characteristics
- High thermal cycling performance
- Low thermal resistance

**SYMBOL**

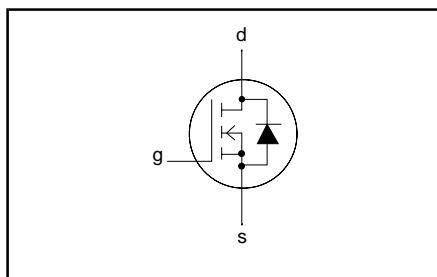

**QUICK REFERENCE DATA**

|                             |
|-----------------------------|
| $V_{DSS} = 600\text{ V}$    |
| $I_D = 1.9\text{ A}$        |
| $R_{DS(ON)} \leq 6\ \Omega$ |

**GENERAL DESCRIPTION**

N-channel, enhancement mode field-effect power transistor, intended for use in off-line switched mode power supplies, T.V. and computer monitor power supplies, d.c. to d.c. converters, motor control circuits and general purpose switching applications.

The PHP2N60E is supplied in the SOT78 (TO220AB) conventional leaded package.  
The PHB2N60E is supplied in the SOT404 surface mounting package.  
The PHD2N60E is supplied in the SOT428 surface mounting package.

**PINNING**

| PIN | DESCRIPTION        |
|-----|--------------------|
| 1   | gate               |
| 2   | drain <sup>1</sup> |
| 3   | source             |
| tab | drain              |

**SOT78 (TO220AB)**

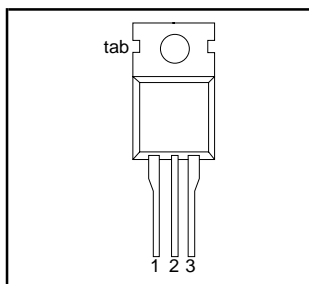

**SOT404**

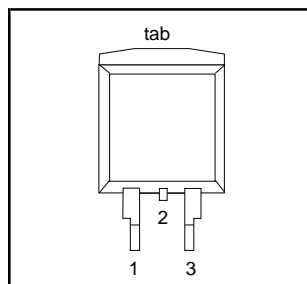

**SOT428**

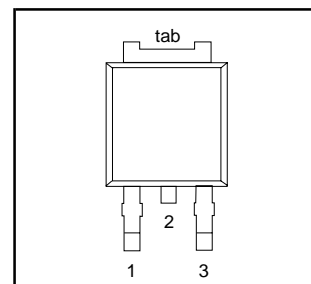

**LIMITING VALUES**

Limiting values in accordance with the Absolute Maximum System (IEC 134)

| SYMBOL         | PARAMETER                                        | CONDITIONS                                                                                | MIN. | MAX.     | UNIT             |
|----------------|--------------------------------------------------|-------------------------------------------------------------------------------------------|------|----------|------------------|
| $V_{DSS}$      | Drain-source voltage                             | $T_j = 25\text{ }^\circ\text{C to }150\text{ }^\circ\text{C}$                             | -    | 600      | V                |
| $V_{DGR}$      | Drain-gate voltage                               | $T_j = 25\text{ }^\circ\text{C to }150\text{ }^\circ\text{C}; R_{GS} = 20\text{ k}\Omega$ | -    | 600      | V                |
| $V_{GS}$       | Gate-source voltage                              |                                                                                           | -    | $\pm 30$ | V                |
| $I_D$          | Continuous drain current                         | $T_{mb} = 25\text{ }^\circ\text{C}; V_{GS} = 10\text{ V}$                                 | -    | 1.9      | A                |
|                |                                                  | $T_{mb} = 100\text{ }^\circ\text{C}; V_{GS} = 10\text{ V}$                                | -    | 1.2      | A                |
| $I_{DM}$       | Pulsed drain current                             | $T_{mb} = 25\text{ }^\circ\text{C}$                                                       | -    | 7.6      | A                |
| $P_D$          | Total dissipation                                | $T_{mb} = 25\text{ }^\circ\text{C}$                                                       | -    | 50       | W                |
| $T_j, T_{stg}$ | Operating junction and storage temperature range |                                                                                           | -55  | 150      | $^\circ\text{C}$ |

<sup>1</sup> It is not possible to make connection to pin 2 of the SOT428 or SOT404 packages.

## PowerMOS transistors Avalanche energy rated

## PHP2N60E, PHB2N60E, PHD2N60E

### AVALANCHE ENERGY LIMITING VALUES

Limiting values in accordance with the Absolute Maximum System (IEC 134)

| SYMBOL           | PARAMETER                                       | CONDITIONS                                                                                                                                                                                                                  | MIN. | MAX. | UNIT |
|------------------|-------------------------------------------------|-----------------------------------------------------------------------------------------------------------------------------------------------------------------------------------------------------------------------------|------|------|------|
| $E_{AS}$         | Non-repetitive avalanche energy                 | Unclamped inductive load, $I_{AS} = 1.3 \text{ A}$ ; $t_p = 0.2 \text{ ms}$ ; $T_j$ prior to avalanche = $25^\circ\text{C}$ ; $V_{DD} \leq 50 \text{ V}$ ; $R_{GS} = 50 \Omega$ ; $V_{GS} = 10 \text{ V}$ ; refer to fig:17 | -    | 102  | mJ   |
| $E_{AR}$         | Repetitive avalanche energy <sup>2</sup>        | $I_{AR} = 1.9 \text{ A}$ ; $t_p = 2.5 \mu\text{s}$ ; $T_j$ prior to avalanche = $25^\circ\text{C}$ ; $R_{GS} = 50 \Omega$ ; $V_{GS} = 10 \text{ V}$ ; refer to fig:18                                                       | -    | 3.7  | mJ   |
| $I_{AS}, I_{AR}$ | Repetitive and non-repetitive avalanche current |                                                                                                                                                                                                                             | -    | 1.9  | A    |

### THERMAL RESISTANCES

| SYMBOL         | PARAMETER                                    | CONDITIONS                                                                               | MIN. | TYP.     | MAX. | UNIT       |
|----------------|----------------------------------------------|------------------------------------------------------------------------------------------|------|----------|------|------------|
| $R_{th\ j-mb}$ | Thermal resistance junction to mounting base |                                                                                          | -    | -        | 2.5  | K/W        |
| $R_{th\ j-a}$  | Thermal resistance junction to ambient       | SOT78 package, in free air<br>SOT404 and SOT428 packages, pcb mounted, minimum footprint | -    | 60<br>50 | -    | K/W<br>K/W |

<sup>2</sup> pulse width and repetition rate limited by  $T_j$  max.

## PowerMOS transistors Avalanche energy rated

## PHP2N60E, PHB2N60E, PHD2N60E

### ELECTRICAL CHARACTERISTICS

$T_j = 25\text{ °C}$  unless otherwise specified

| SYMBOL                                  | PARAMETER                                              | CONDITIONS                                                                                                           | MIN. | TYP. | MAX. | UNIT          |
|-----------------------------------------|--------------------------------------------------------|----------------------------------------------------------------------------------------------------------------------|------|------|------|---------------|
| $V_{(BR)DSS}$                           | Drain-source breakdown voltage                         | $V_{GS} = 0\text{ V}; I_D = 0.25\text{ mA}$                                                                          | 600  | -    | -    | V             |
| $\frac{\Delta V_{(BR)DSS}}{\Delta T_j}$ | Drain-source breakdown voltage temperature coefficient | $V_{DS} = V_{GS}; I_D = 0.25\text{ mA}$                                                                              | -    | 0.1  | -    | %/K           |
| $R_{DS(ON)}$                            | Drain-source on resistance                             | $V_{GS} = 10\text{ V}; I_D = 1\text{ A}$                                                                             | -    | 4.6  | 6    | $\Omega$      |
| $V_{GS(TO)}$                            | Gate threshold voltage                                 | $V_{DS} = V_{GS}; I_D = 0.25\text{ mA}$                                                                              | 2.0  | 3.0  | 4.0  | V             |
| $g_{fs}$                                | Forward transconductance                               | $V_{DS} = 30\text{ V}; I_D = 1\text{ A}$                                                                             | 0.5  | 1.4  | -    | S             |
| $I_{DSS}$                               | Drain-source leakage current                           | $V_{DS} = 600\text{ V}; V_{GS} = 0\text{ V}$                                                                         | -    | 1    | 100  | $\mu\text{A}$ |
| $I_{GSS}$                               | Gate-source leakage current                            | $V_{DS} = 480\text{ V}; V_{GS} = 0\text{ V}; T_j = 125\text{ °C}$<br>$V_{GS} = \pm 30\text{ V}; V_{DS} = 0\text{ V}$ | -    | 50   | 500  | $\mu\text{A}$ |
| $Q_{g(tot)}$                            | Total gate charge                                      | $I_D = 2\text{ A}; V_{DD} = 480\text{ V}; V_{GS} = 10\text{ V}$                                                      | -    | 20   | 25   | nC            |
| $Q_{gs}$                                | Gate-source charge                                     |                                                                                                                      | -    | 2    | 3    | nC            |
| $Q_{gd}$                                | Gate-drain (Miller) charge                             |                                                                                                                      | -    | 9    | 15   | nC            |
| $t_{d(on)}$                             | Turn-on delay time                                     | $V_{DD} = 300\text{ V}; R_D = 150\text{ }\Omega;$                                                                    | -    | 10   | -    | ns            |
| $t_r$                                   | Turn-on rise time                                      | $R_G = 24\text{ }\Omega$                                                                                             | -    | 20   | -    | ns            |
| $t_{d(off)}$                            | Turn-off delay time                                    |                                                                                                                      | -    | 60   | -    | ns            |
| $t_f$                                   | Turn-off fall time                                     |                                                                                                                      | -    | 20   | -    | ns            |
| $L_d$                                   | Internal drain inductance                              | Measured from tab to centre of die                                                                                   | -    | 3.5  | -    | nH            |
| $L_d$                                   | Internal drain inductance                              | Measured from drain lead to centre of die (SOT78 package only)                                                       | -    | 4.5  | -    | nH            |
| $L_s$                                   | Internal source inductance                             | Measured from source lead to source bond pad                                                                         | -    | 7.5  | -    | nH            |
| $C_{iss}$                               | Input capacitance                                      | $V_{GS} = 0\text{ V}; V_{DS} = 25\text{ V}; f = 1\text{ MHz}$                                                        | -    | 236  | -    | pF            |
| $C_{oss}$                               | Output capacitance                                     |                                                                                                                      | -    | 34   | -    | pF            |
| $C_{rss}$                               | Feedback capacitance                                   |                                                                                                                      | -    | 20   | -    | pF            |

### SOURCE-DRAIN DIODE RATINGS AND CHARACTERISTICS

$T_j = 25\text{ °C}$  unless otherwise specified

| SYMBOL   | PARAMETER                              | CONDITIONS                                                                | MIN. | TYP. | MAX. | UNIT          |
|----------|----------------------------------------|---------------------------------------------------------------------------|------|------|------|---------------|
| $I_S$    | Continuous source current (body diode) | $T_{mb} = 25\text{ °C}$                                                   | -    | -    | 1.9  | A             |
| $I_{SM}$ | Pulsed source current (body diode)     | $T_{mb} = 25\text{ °C}$                                                   | -    | -    | 7.6  | A             |
| $V_{SD}$ | Diode forward voltage                  | $I_S = 2\text{ A}; V_{GS} = 0\text{ V}$                                   | -    | -    | 1.2  | V             |
| $t_{rr}$ | Reverse recovery time                  | $I_S = 2\text{ A}; V_{GS} = 0\text{ V}; di/dt = 100\text{ A}/\mu\text{s}$ | -    | 360  | -    | ns            |
| $Q_{rr}$ | Reverse recovery charge                |                                                                           | -    | 2.4  | -    | $\mu\text{C}$ |

PowerMOS transistors  
Avalanche energy rated

PHP2N60E, PHB2N60E, PHD2N60E

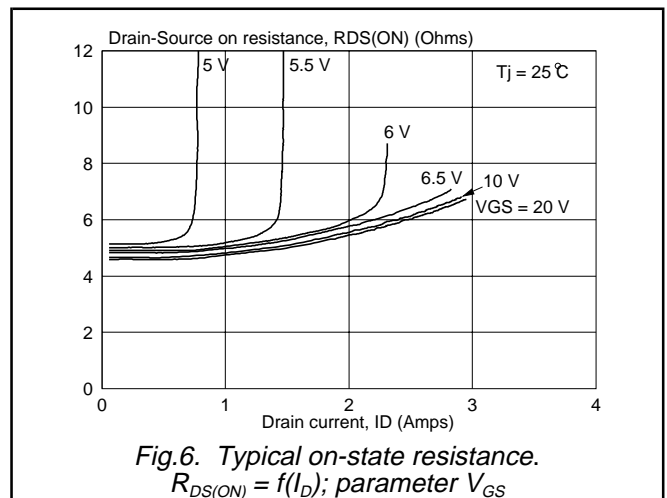
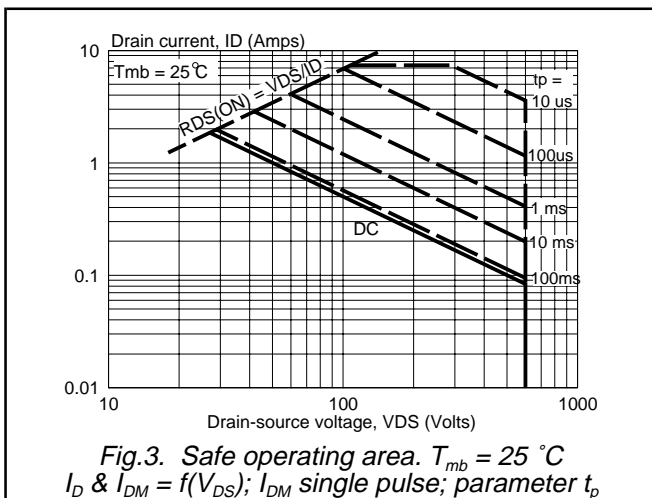
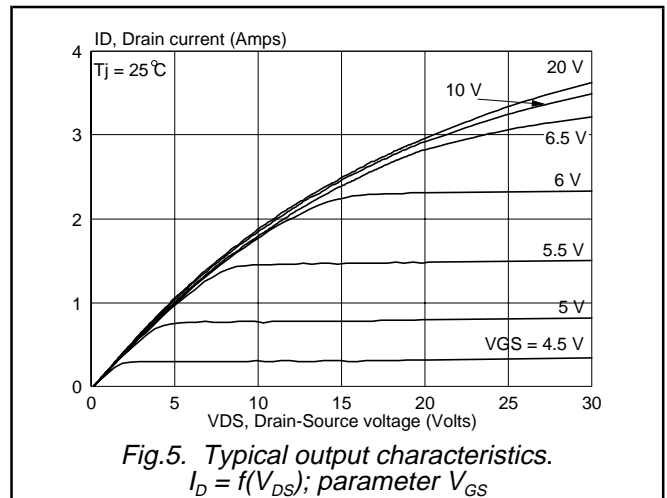
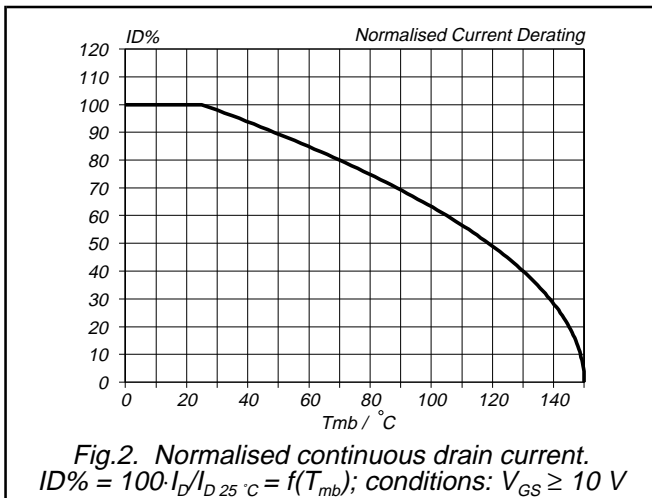
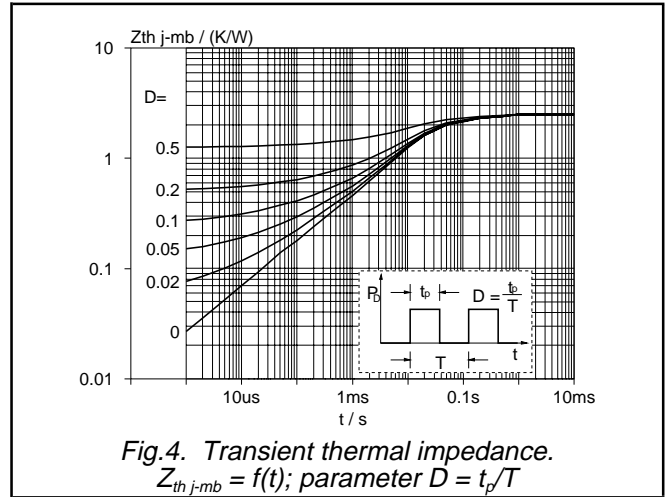
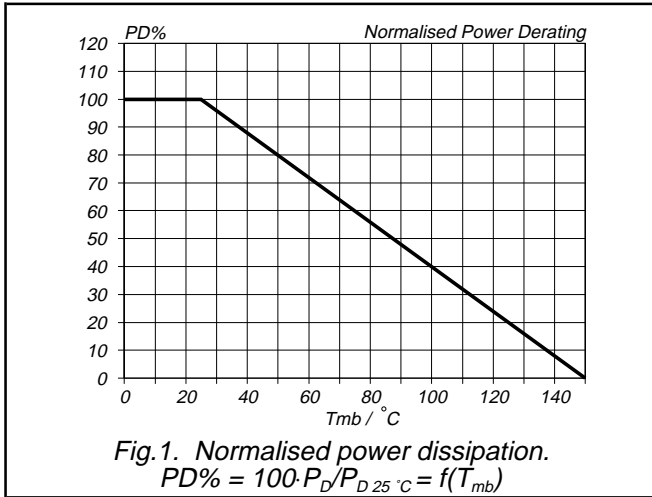

PowerMOS transistors  
Avalanche energy rated

PHP2N60E, PHB2N60E, PHD2N60E

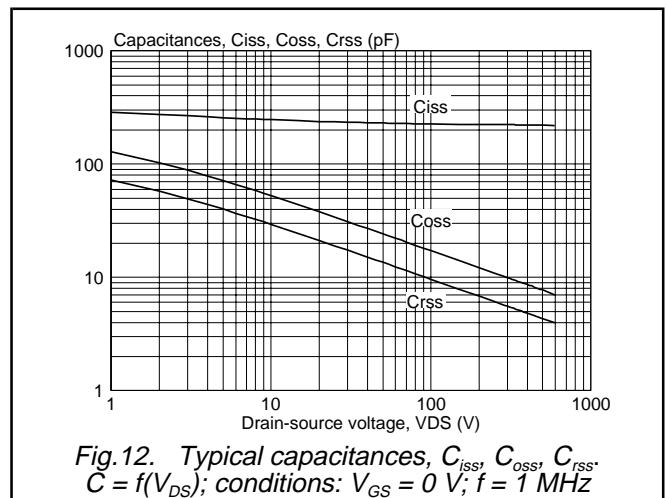
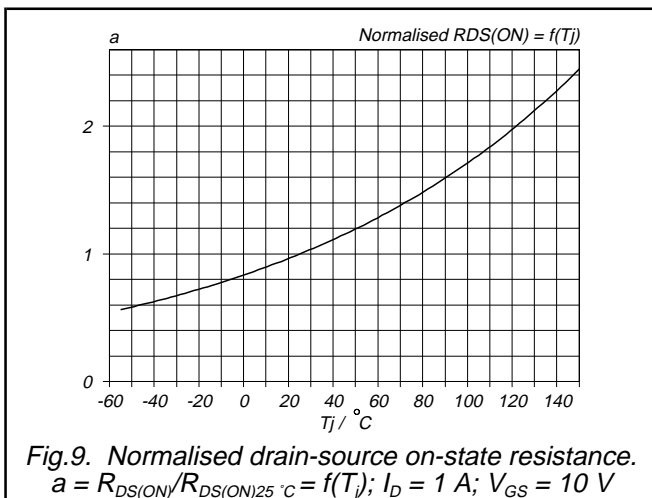
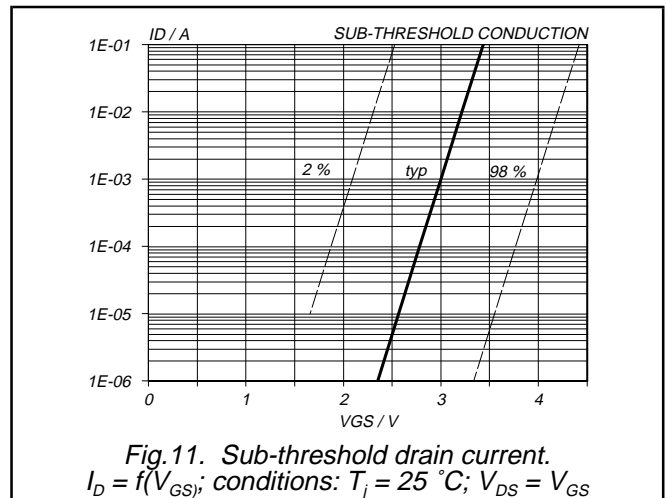
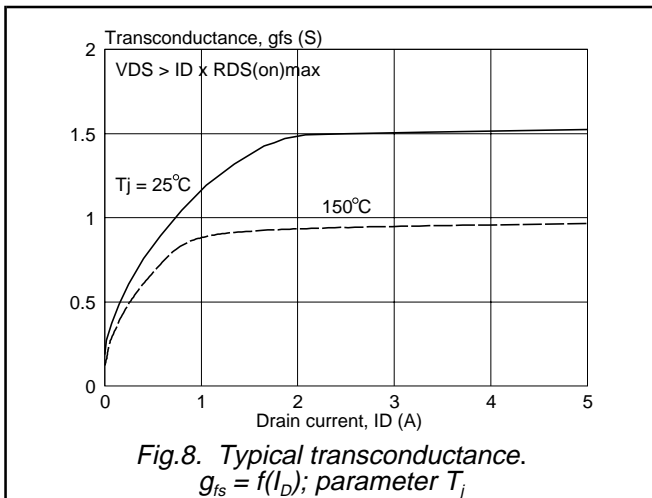
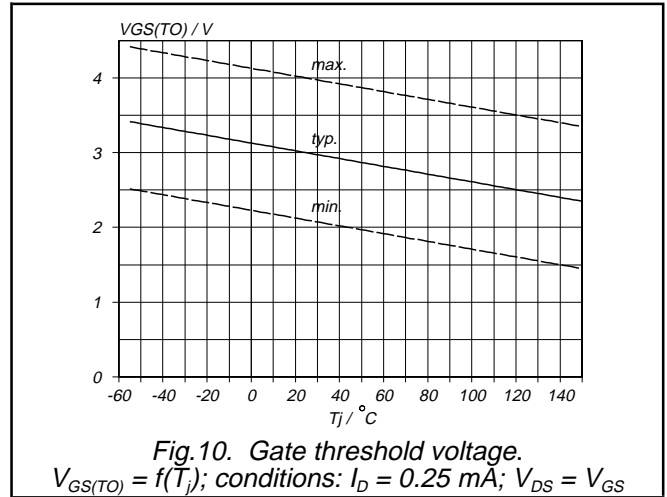
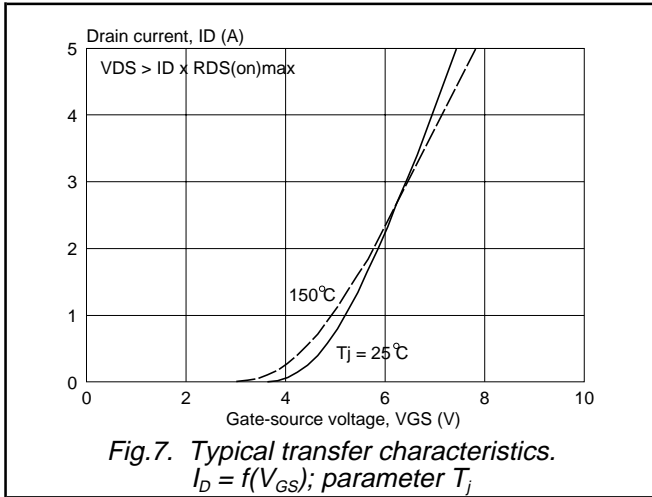

PowerMOS transistors  
Avalanche energy rated

PHP2N60E, PHB2N60E, PHD2N60E

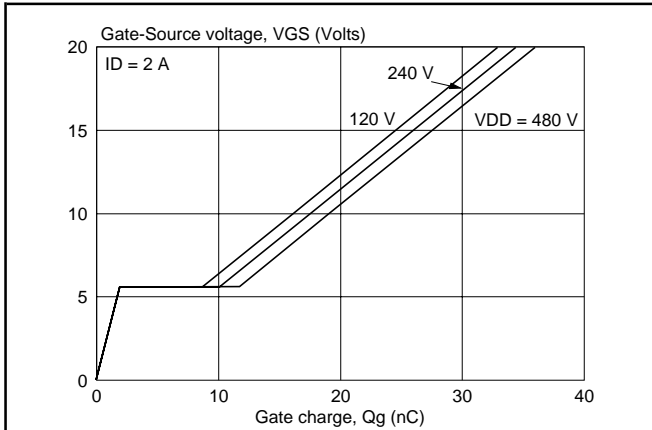

Fig. 13. Typical turn-on gate-charge characteristics.  
 $V_{GS} = f(Q_G)$ ; parameter  $V_{DS}$

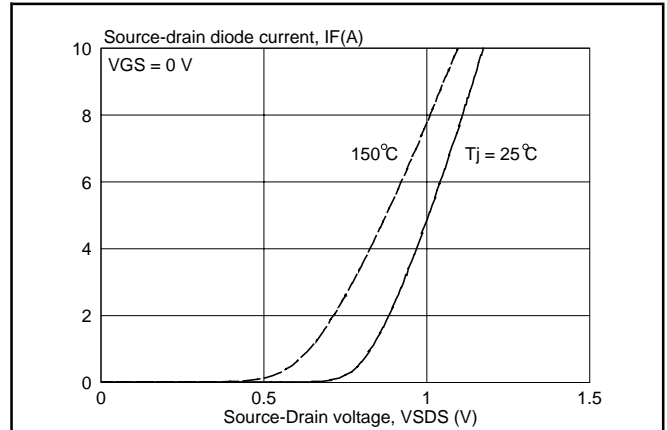

Fig. 16. Source-Drain diode characteristic.  
 $I_F = f(V_{SDS})$ ; parameter  $T_j$

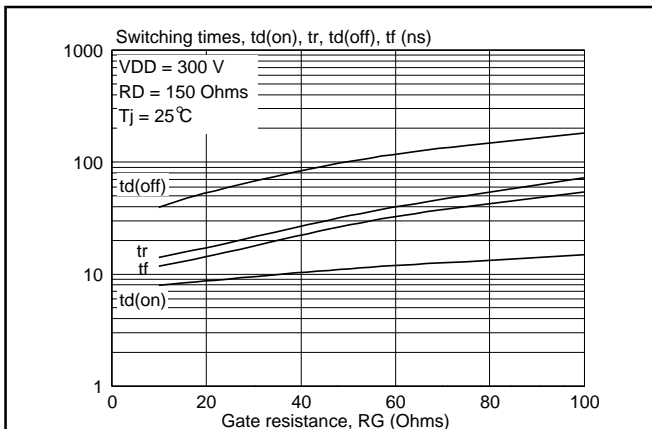

Fig. 14. Typical switching times;  $t_{d(on)}$ ,  $t_r$ ,  $t_{d(off)}$ ,  $t_f = f(R_G)$

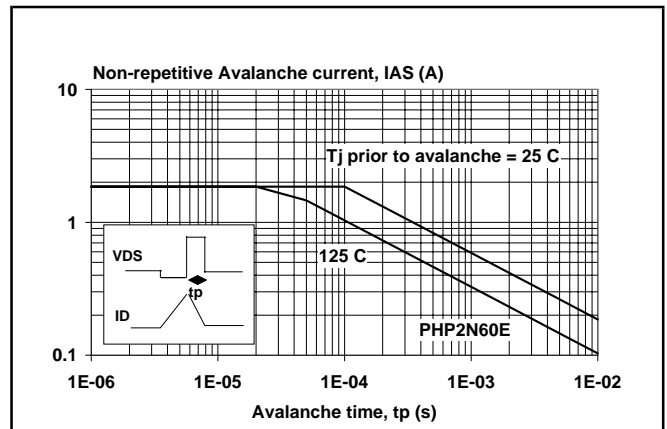

Fig. 17. Maximum permissible non-repetitive avalanche current ( $I_{AS}$ ) versus avalanche time ( $t_p$ ); unclamped inductive load

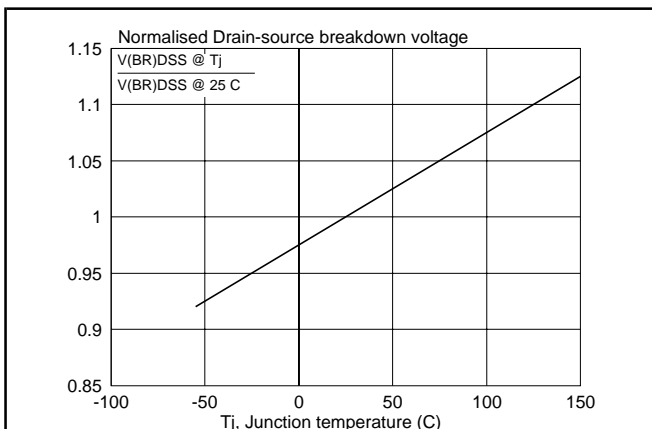

Fig. 15. Normalised drain-source breakdown voltage;  
 $V_{(BR)DSS} / V_{(BR)DSS 25°C} = f(T_j)$

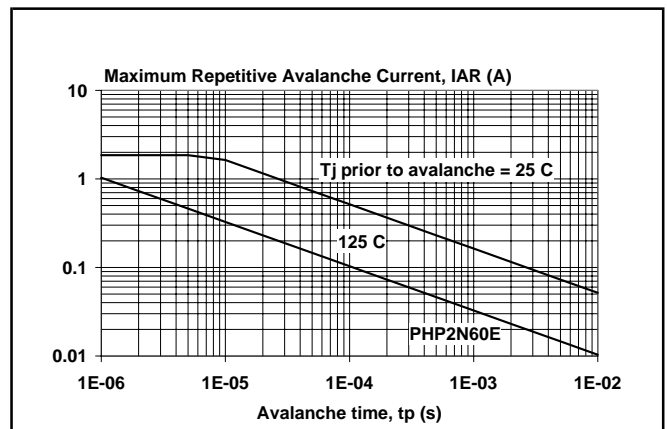
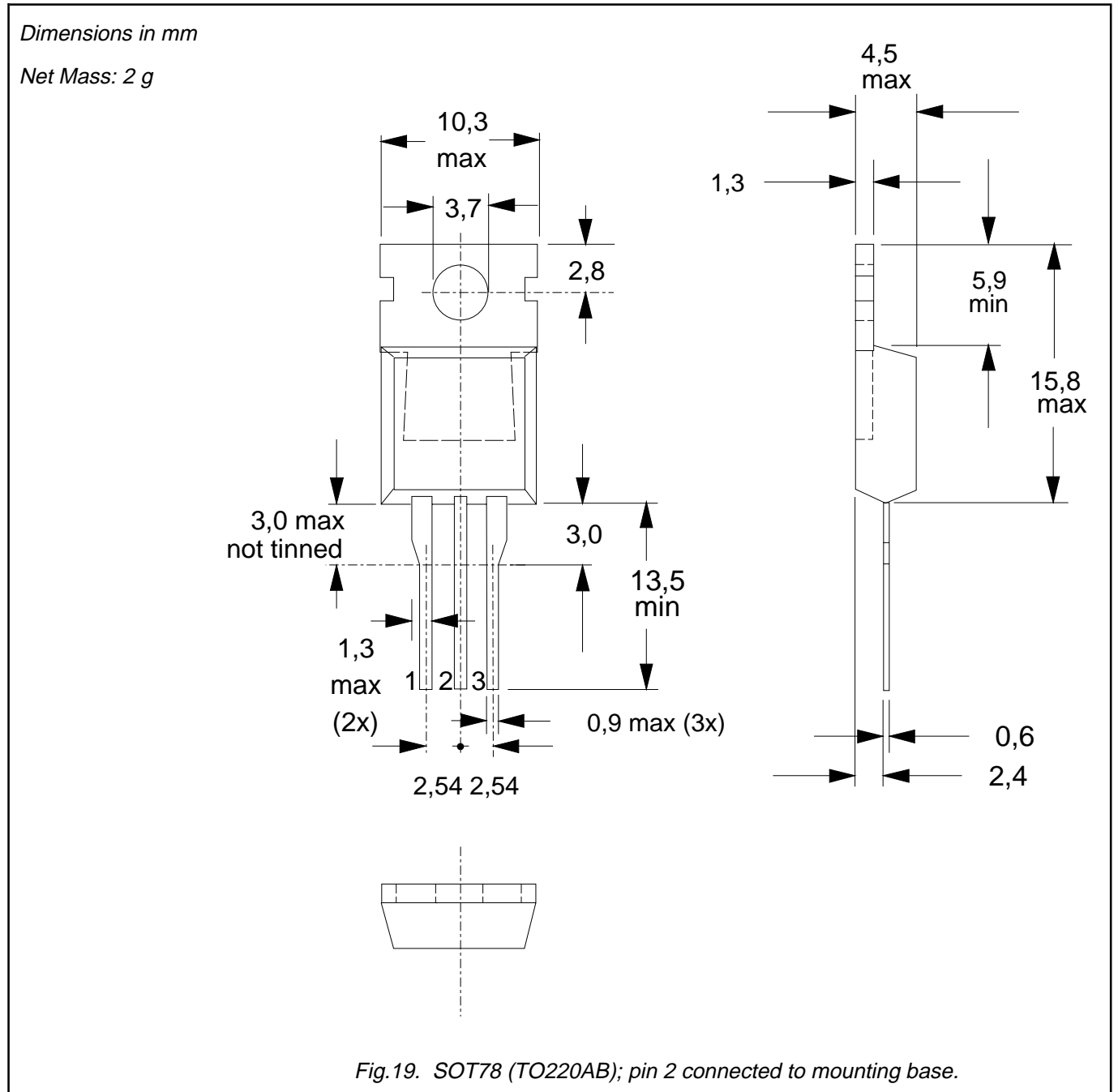

Fig. 18. Maximum permissible repetitive avalanche current ( $I_{AR}$ ) versus avalanche time ( $t_p$ )

PowerMOS transistors  
Avalanche energy rated

PHP2N60E, PHB2N60E, PHD2N60E

**MECHANICAL DATA**



**Notes**

1. Observe the general handling precautions for electrostatic-discharge sensitive devices (ESDs) to prevent damage to MOS gate oxide.
2. Refer to mounting instructions for SOT78 (TO220) envelopes.
3. Epoxy meets UL94 V0 at 1/8".

PowerMOS transistors  
Avalanche energy rated

PHP2N60E, PHB2N60E, PHD2N60E

**MECHANICAL DATA**

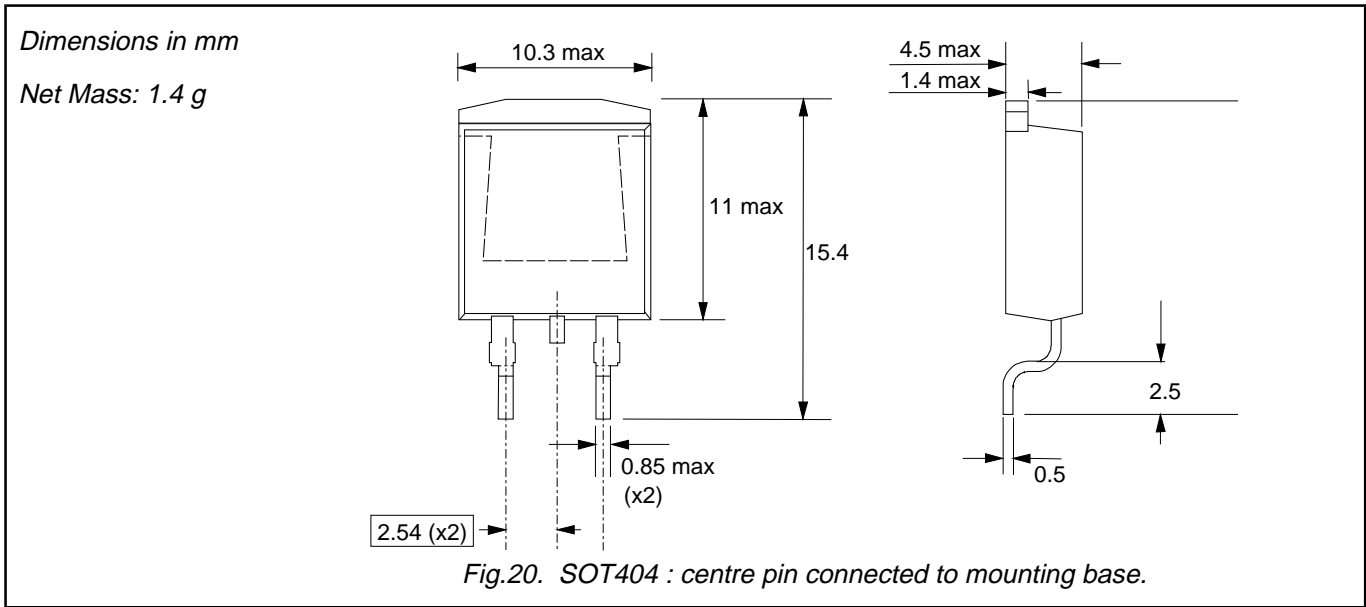

**MOUNTING INSTRUCTIONS**

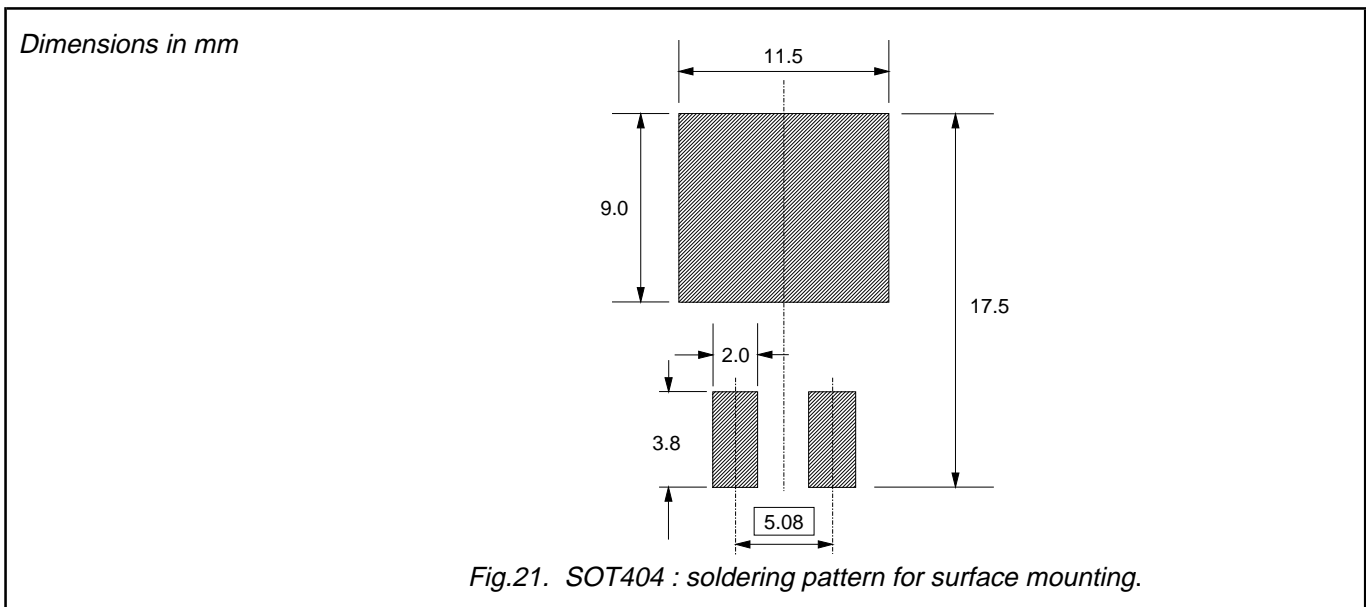

**Notes**

1. Observe the general handling precautions for electrostatic-discharge sensitive devices (ESDs) to prevent damage to MOS gate oxide.
2. Epoxy meets UL94 V0 at 1/8".



PowerMOS transistors  
Avalanche energy rated

PHP2N60E, PHB2N60E, PHD2N60E

**MECHANICAL DATA**

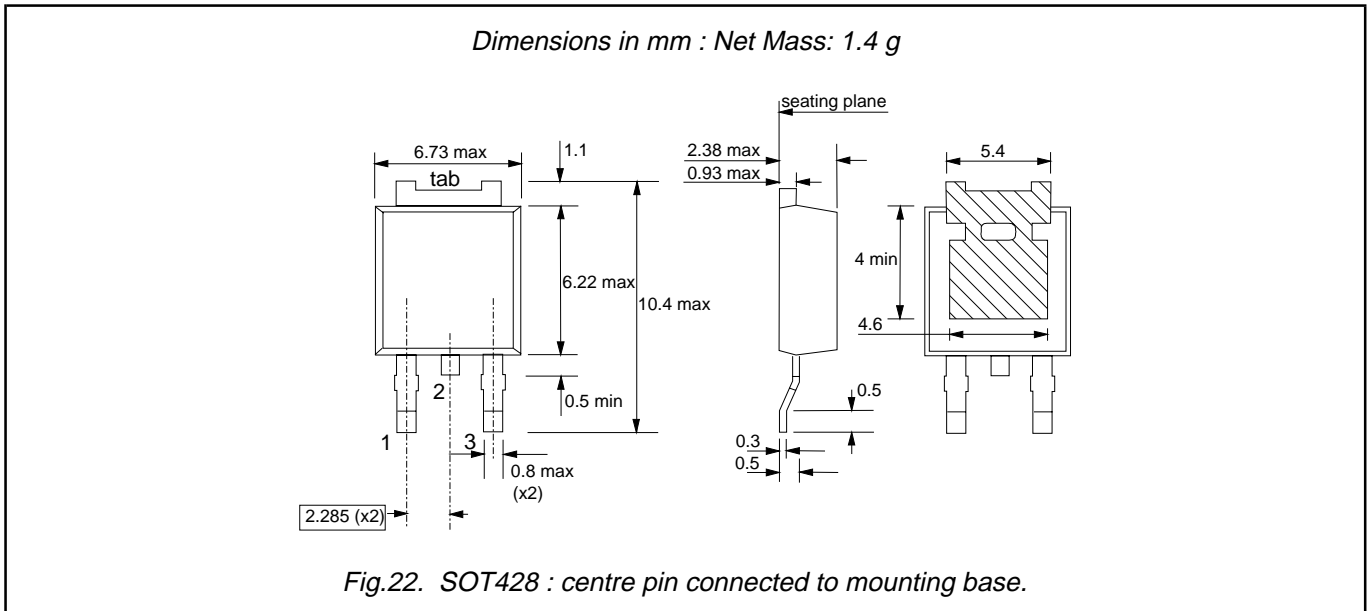

**MOUNTING INSTRUCTIONS**

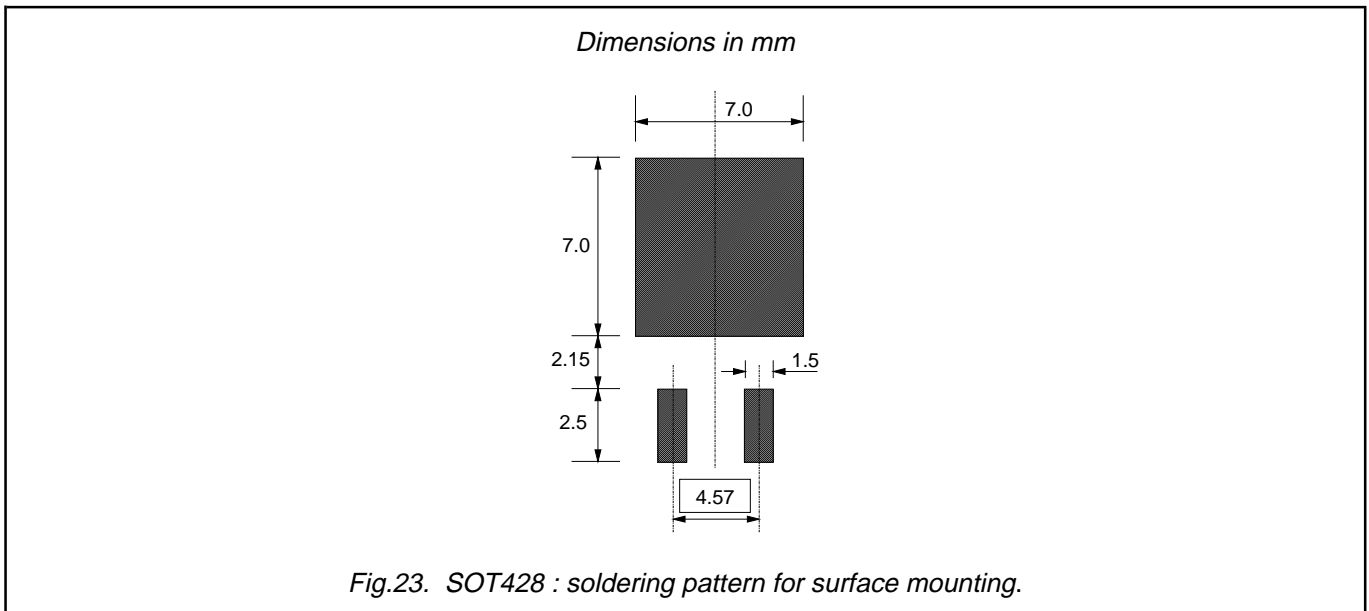

**Notes**

1. Observe the general handling precautions for electrostatic-discharge sensitive devices (ESDs) to prevent damage to MOS gate oxide.
2. Epoxy meets UL94 V0 at 1/8".

PowerMOS transistors  
Avalanche energy rated

PHP2N60E, PHB2N60E, PHD2N60E

## DEFINITIONS

|                                                                                                                                                                                                                                                                                                                                                                                                                                                            |                                                                                       |
|------------------------------------------------------------------------------------------------------------------------------------------------------------------------------------------------------------------------------------------------------------------------------------------------------------------------------------------------------------------------------------------------------------------------------------------------------------|---------------------------------------------------------------------------------------|
| <b>Data sheet status</b>                                                                                                                                                                                                                                                                                                                                                                                                                                   |                                                                                       |
| Objective specification                                                                                                                                                                                                                                                                                                                                                                                                                                    | This data sheet contains target or goal specifications for product development.       |
| Preliminary specification                                                                                                                                                                                                                                                                                                                                                                                                                                  | This data sheet contains preliminary data; supplementary data may be published later. |
| Product specification                                                                                                                                                                                                                                                                                                                                                                                                                                      | This data sheet contains final product specifications.                                |
| <b>Limiting values</b>                                                                                                                                                                                                                                                                                                                                                                                                                                     |                                                                                       |
| Limiting values are given in accordance with the Absolute Maximum Rating System (IEC 134). Stress above one or more of the limiting values may cause permanent damage to the device. These are stress ratings only and operation of the device at these or at any other conditions above those given in the Characteristics sections of this specification is not implied. Exposure to limiting values for extended periods may affect device reliability. |                                                                                       |
| <b>Application information</b>                                                                                                                                                                                                                                                                                                                                                                                                                             |                                                                                       |
| Where application information is given, it is advisory and does not form part of the specification.                                                                                                                                                                                                                                                                                                                                                        |                                                                                       |
| © Philips Electronics N.V. 1998                                                                                                                                                                                                                                                                                                                                                                                                                            |                                                                                       |
| All rights are reserved. Reproduction in whole or in part is prohibited without the prior written consent of the copyright owner.                                                                                                                                                                                                                                                                                                                          |                                                                                       |
| The information presented in this document does not form part of any quotation or contract, it is believed to be accurate and reliable and may be changed without notice. No liability will be accepted by the publisher for any consequence of its use. Publication thereof does not convey nor imply any license under patent or other industrial or intellectual property rights.                                                                       |                                                                                       |

## LIFE SUPPORT APPLICATIONS

These products are not designed for use in life support appliances, devices or systems where malfunction of these products can be reasonably expected to result in personal injury. Philips customers using or selling these products for use in such applications do so at their own risk and agree to fully indemnify Philips for any damages resulting from such improper use or sale.